

### The Big Deal:

- Ultra Flat Gain Response:  
± 0.4 dB over 900-2150 MHz
- Excellent Combination of gain, P1dB, IP3 and NF
- 50Ω Input and Output:  
no External Components Required

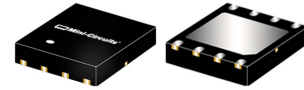

CASE STYLE: DL1636

### Product Overview:

YSF-2151+ is an advanced amplifier module in a Mini-Circuits System In Package **MSiP<sup>®</sup>**. This module is fully matched to 50Ω in/out impedance and has built-in Input & Output DC block capacitors. It is enclosed in a 5 x 6 mm MCLP plastic package. The YSF-2151+ uses E-PHEMT technology enabling it to work with a single positive supply voltage.

### Key Features

Feature	Advantages
Superior gain flatness ± 0.4dB	The YSF-2151+ provides industry leading gain flatness over the full satellite communications L Band (900-2150 MHz) making this ideal for use in applications where gain-flatness and repeatability are critical performance requirements.
High Gain	The YSF-2151+ is a two-stage design with internal feedback and bias to provide flat 20 dB nominal gain, supporting applications where a single gain block must overcome large system losses such as long cable runs and lossy components.
Strong Combination of Performance	The YSF-2151+ provides a strong combination of performance parameters including high gain (20 dB), high IP3 (+35 dBm) and P1dB (+20 dBm) and low noise figures (2.8 dB) that are difficult to achieve in a single stage design and available only in the YSF amplifier series.
Integrated Matching, DC Blocking and Bias in Small Package	The YSF-2151+ includes all support circuits including: Matching, Bias and DC Blocking, all integrated into a single 5x6mm package making the total footprint equal to or smaller than most solutions
Excellent Return Loss	The YSF-2151+ includes integrated input and output matching and bias circuits to make this amplifier a simple, complete drop-in solution. The matching circuits provide excellent output return loss (20dB), and are designed to give optimal P1dB and IP3 performance in a 50Ω environment.
High Reverse Isolation	With 30 dB of reverse isolation – the YSF-2151+ is an ideal gain block for use in integrated systems to minimize VSWR interactions resulting from cascading highly reflective components, such as sharp filters.

#### Notes

- A. Performance and quality attributes and conditions not expressly stated in this specification document are intended to be excluded and do not form a part of this specification document.  
 B. Electrical specifications and performance data contained in this specification document are based on Mini-Circuit's applicable established test performance criteria and measurement instructions.  
 C. The parts covered by this specification document are subject to Mini-Circuits standard limited warranty and terms and conditions (collectively, "Standard Terms"); Purchasers of this part are entitled to the rights and benefits contained therein. For a full statement of the Standard Terms and the exclusive rights and remedies thereunder, please visit Mini-Circuits' website at [www.minicircuits.com/MCLStore/terms.jsp](http://www.minicircuits.com/MCLStore/terms.jsp)



# Flat Gain Amplifier

0.9-2.15 GHz

## Product Features

- Matched 50-ohm surface mount amplifier
- High gain, 20 dB typ. at 2 GHz
- Up to +20 dBm typ. output power at 2 GHz
- High IP3, +35 dBm at 2 GHz
- Low Noise Figure, 2.8 dB typ. at 2 GHz
- High directivity, 30 dB isolation
- Internal Input & Output DC Block
- Separate terminal for DC
- Protected by us patent 8,994,157

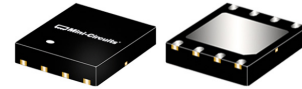

**YSF-2151+**

CASE STYLE: DL1636

## Typical Applications

- Cellular
- Portable Wireless
- Satellite Communications
- Receivers & transmitters

**+RoHS Compliant**

The +Suffix identifies RoHS Compliance. See our web site for RoHS Compliance methodologies and qualifications

## General Description

YSF-2151+ is an advanced amplifier module in a Mini-Circuits System In Package **MSiP<sup>®</sup>**. This module is fully matched to 50Ω in/out impedance and has built-in Input & Output DC block capacitors. It is enclosed in a 5 x 6 mm MCLP plastic package. The YSF-2151+ uses E-PHEMT\* technology enabling it to work with a single positive supply voltage.

### simplified schematic and pad description

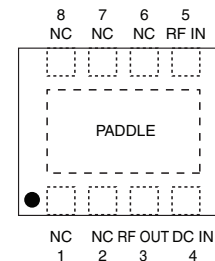
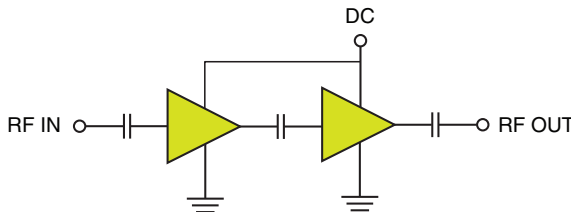

Function	Pad Number	Description
RF-IN	5	RF Input
RF-OUT	3	RF Output
DC	4	DC Supply
GND	Paddle	Connected to ground
NOT USED	1,2,6,7,8	No internal connection

\*Enhancement mode Pseudomorphic High Electron Mobility Transistor

**Notes**

- A. Performance and quality attributes and conditions not expressly stated in this specification document are intended to be excluded and do not form a part of this specification document.
- B. Electrical specifications and performance data contained in this specification document are based on Mini-Circuit's applicable established test performance criteria and measurement instructions.
- C. The parts covered by this specification document are subject to Mini-Circuits standard limited warranty and terms and conditions (collectively, "Standard Terms"); Purchasers of this part are entitled to the rights and benefits contained therein. For a full statement of the Standard Terms and the exclusive rights and remedies thereunder, please visit Mini-Circuits' website at [www.minicircuits.com/MCLStore/terms.jsp](http://www.minicircuits.com/MCLStore/terms.jsp)



**Electrical Specifications<sup>(1)</sup> at 25°C, Zo=50Ω unless noted**

Parameter	Condition (MHz)	Min.	Typ.	Max.	Units
Frequency Range		900		2150	MHz
Gain	900	18.2	20.2	22.2	dB
	1600	18.0	20.0	22.0	
	2150	18.0	19.8	22.0	
Gain Flatness			0.4		± dB
Input Return Loss	900	—	10.0		dB
	1600	8.0	10.0		
	2150	—	11.5		
Output Return Loss	900	—	14.0		dB
	1600	16.0	22.0		
	2150	—	23.0		
Reverse Isolation			30.5		dB
Output Power @1 dB compression	900	—	20.0		dBm
	1600	—	20.0		
	2150	18.0	20.0		
Output Power @3 dB compression			21.0		dBm
Output IP3	900	—	36.0		dBm
	1600	30.0	35.0		
	2150	—	35.0		
Noise Figure	900		3.5	—	dB
	1600		3.1	4.1	
	2150		2.6	—	
Device Operating Voltage			5		V
Device Operating Current			118	145	mA
Device Current Variation vs. Temperature <sup>(2)</sup>			2		μA/°C
Device Current Variation vs Voltage			0.002		mA/mV
Thermal Resistance, junction-to-ground lead <sup>(3)</sup>			56		°C/W

<sup>(1)</sup> Measured on Mini-Circuits Characterization test board TB-616+. See Characterization Test Circuit (Fig. 1)

<sup>(2)</sup> D(+85°C to -45°C)

<sup>(3)</sup> Thermal Resistance=  $\frac{\text{Hot spot temperature} - \text{Ground lead temperature}}{\text{Power Dissipation}}$

**Absolute Maximum Ratings**

Parameter	Ratings	Units
Operating Temperature <sup>(4)</sup>	-40 to 85	°C
Storage Temperature	-65 to 150	°C
DC Voltage on Pad 4	7	V
Power Dissipation	1.5	W
Input Power	21	dBm

Note: Permanent damage may occur if any of these limits are exceeded. These ratings are not intended for continuous normal operation.

<sup>(4)</sup> Case is defined as ground paddle.

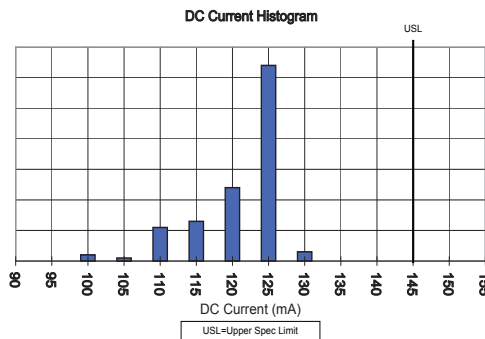

**Notes**

- A. Performance and quality attributes and conditions not expressly stated in this specification document are intended to be excluded and do not form a part of this specification document.
- B. Electrical specifications and performance data contained in this specification document are based on Mini-Circuit's applicable established test performance criteria and measurement instructions.
- C. The parts covered by this specification document are subject to Mini-Circuits standard limited warranty and terms and conditions (collectively, "Standard Terms"); Purchasers of this part are entitled to the rights and benefits contained therein. For a full statement of the Standard Terms and the exclusive rights and remedies thereunder, please visit Mini-Circuits' website at [www.minicircuits.com/MCLStore/terms.jsp](http://www.minicircuits.com/MCLStore/terms.jsp)



### Characterization Test Circuit

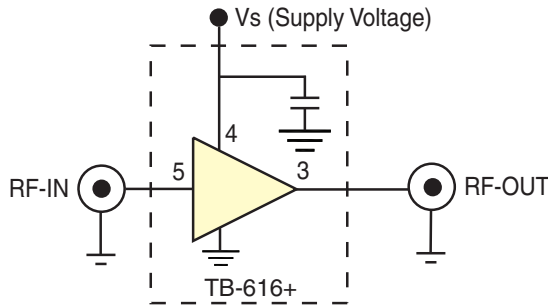

**Fig 1.** Block Diagram of Test Circuit used for characterization. (DUT soldered on Mini-Circuits Characterization Test Fixture TB-616+) Gain, Return loss, Output power at 1dB compression (P1 dB), Output IP3 (OIP3) and Noise Figure measured using Agilent's N5242A PNA-X microwave network analyzer.

**Conditions:**

1. Gain: Pin= -25dBm
2. Output IP3 (OIP3): Two tones, spaced 1 MHz apart, 0 dBm/tone at output.

### Recommended Application Circuit

(refer to evaluation board for PCB Layout and component values)

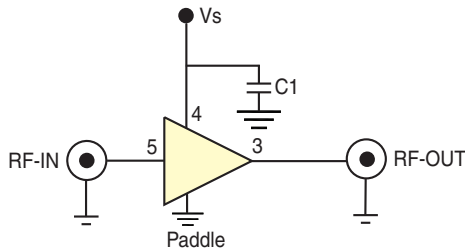

**Fig 2.** Recommended Application Circuit

### Product Marking

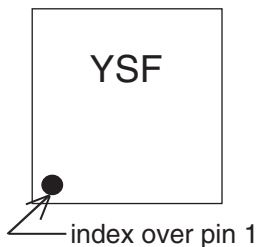

**Notes**

- A. Performance and quality attributes and conditions not expressly stated in this specification document are intended to be excluded and do not form a part of this specification document.
- B. Electrical specifications and performance data contained in this specification document are based on Mini-Circuit's applicable established test performance criteria and measurement instructions.
- C. The parts covered by this specification document are subject to Mini-Circuits standard limited warranty and terms and conditions (collectively, "Standard Terms"); Purchasers of this part are entitled to the rights and benefits contained therein. For a full statement of the Standard Terms and the exclusive rights and remedies thereunder, please visit Mini-Circuits' website at [www.minicircuits.com/MCLStore/terms.jsp](http://www.minicircuits.com/MCLStore/terms.jsp)

<b>Additional Detailed Technical Information</b>	
<i>additional information is available on our dash board. To access this information <a href="#">click here</a></i>	
<b>Performance Data</b>	Data Table
	Swept Graphs
	S-Parameter (S2P Files) Data Set (.zip file)
<b>Case Style</b>	DL1636 <i>Plastic package, exposed paddle, lead finish: tin/silver/nickel</i>
<b>Tape &amp; Reel</b> Standard quantities available on reel	F68 <i>7" reels with 20, 50, 100, 200, 500 or 1K devices. 13" reels with 2K, or 4K devices.</i>
<b>Suggested Layout for PCB Design</b>	PL-352
<b>Evaluation Board</b>	TB-616-7+
<b>Environmental Ratings</b>	ENV08T1

### ESD Rating

Human Body Model (HBM): Class 1A in accordance with ANSI/ESD STM 5.1 - 2001

Machine Model (MM): Class M1 (25V) in accordance with ANSI/ESD STM5.2-1999



**Attention**  
Observe precautions  
for handling electrostatic  
sensitive devices

### MSL Rating

Moisture Sensitivity: MSL1 in accordance with IPC/JEDEC J-STD-020D

### MSL Test Flow Chart

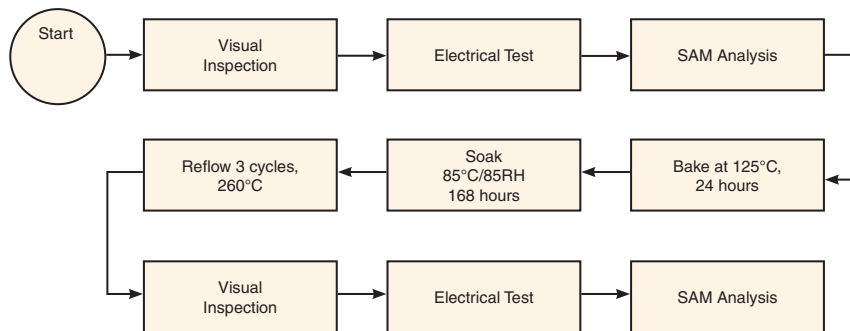

**Notes**

- A. Performance and quality attributes and conditions not expressly stated in this specification document are intended to be excluded and do not form a part of this specification document.
- B. Electrical specifications and performance data contained in this specification document are based on Mini-Circuit's applicable established test performance criteria and measurement instructions.
- C. The parts covered by this specification document are subject to Mini-Circuits standard limited warranty and terms and conditions (collectively, "Standard Terms"); Purchasers of this part are entitled to the rights and benefits contained therein. For a full statement of the Standard Terms and the exclusive rights and remedies thereunder, please visit Mini-Circuits' website at [www.minicircuits.com/MCLStore/terms.jsp](http://www.minicircuits.com/MCLStore/terms.jsp)

